

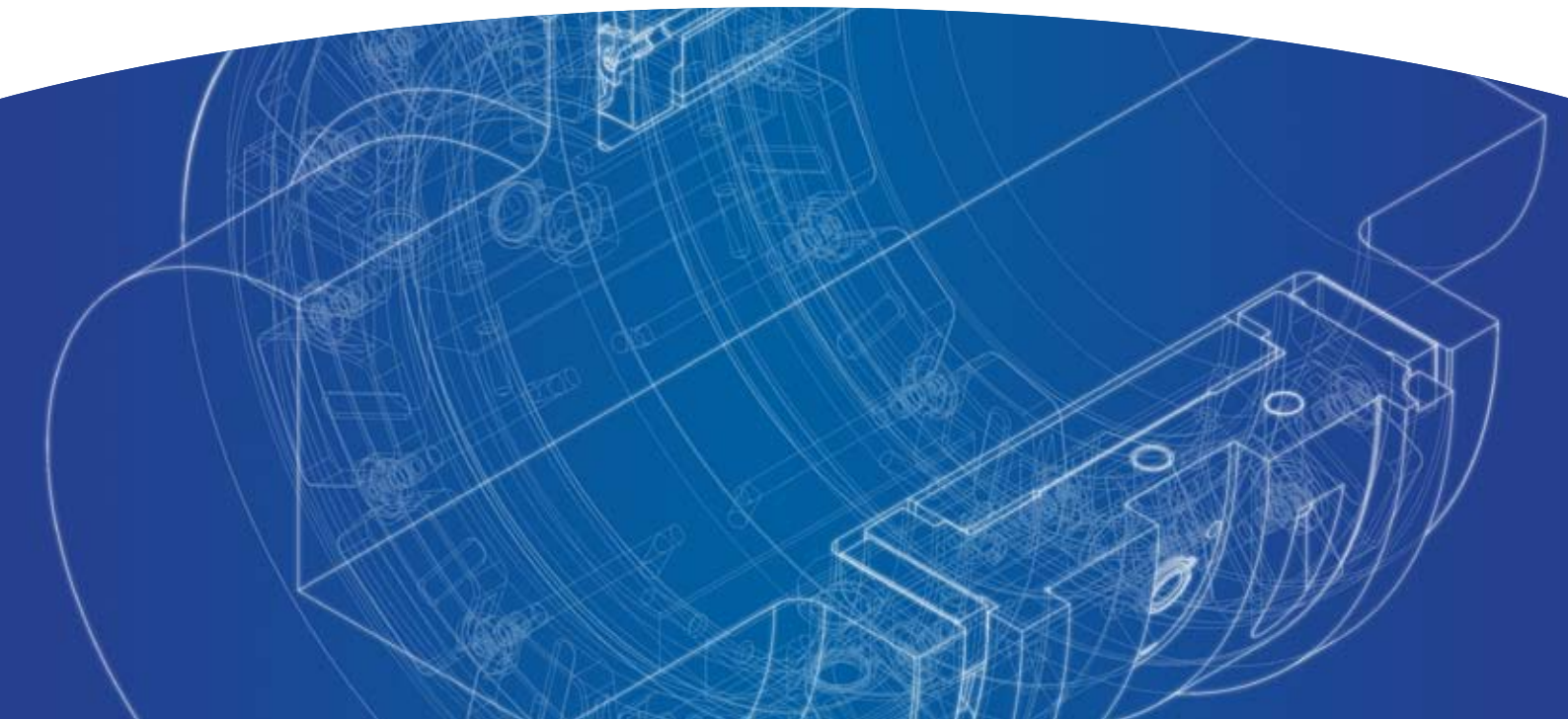

EURO
BEARINGS

DRIVES THE **EXCELLENCE OF DYNAMIC**

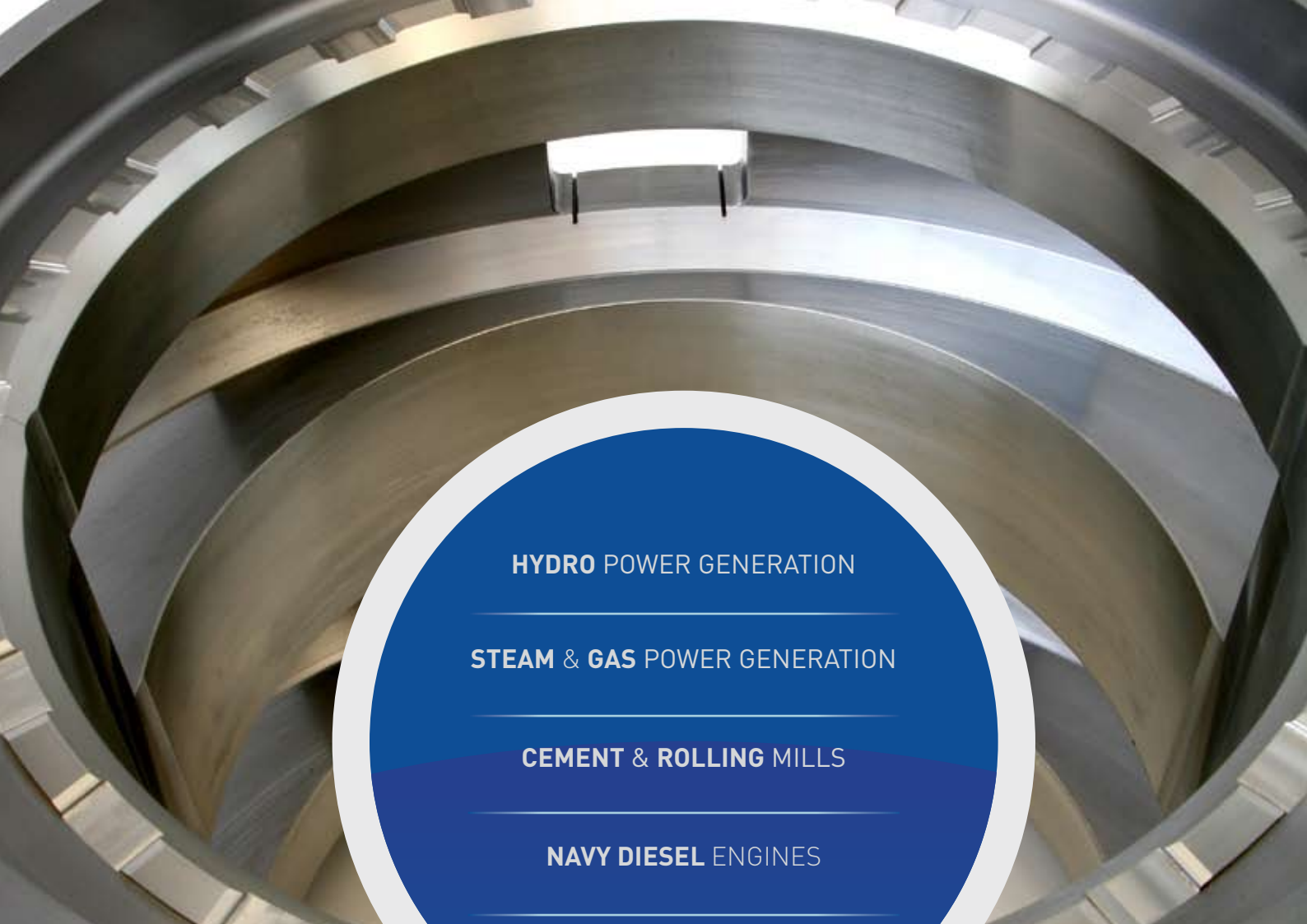



HYDRO POWER GENERATION

STEAM & GAS POWER GENERATION

CEMENT & ROLLING MILLS

NAVY DIESEL ENGINES

GEAR BOXES



QUALIFIED MANAGEMENT
SYSTEM PREPARED TO FACE NEW
OPPORTUNITIES AND MEET NEW
CHALLENGES

COMPANY STRUCTURE IS
CONSTANTLY MOTIVATED TO
MEET OUR CUSTOMER'S TOTAL
SATISFACTION

SPECIALIZED SKILLS
ENSURING GLOBAL
TECHNICAL AND LOGISTIC
SUPPORT

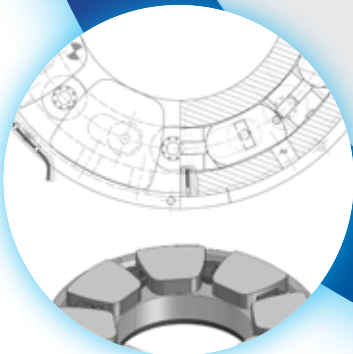
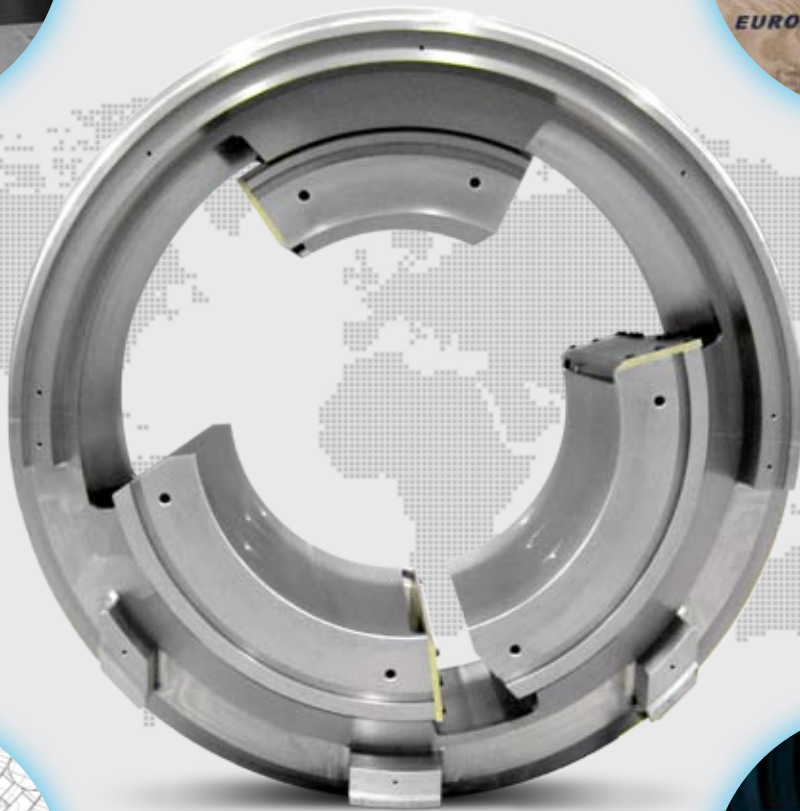

ENGINEERING KNOWLEDGE
SUPPLIES ADVANCED
DYNAMIC SOLUTIONS



SAFE TECH COATING
PROCESSES TO GUARANTEE
MAXIMUM RELIABILITY



TOTAL QUALITY
MISSION DRIVING THE
MANUFACTURING
PROCESSES



COMPANY

KEY PARTNER FOR KEY COMPONENTS



DRIVES THE EXCELLENCE OF DYNAMIC

Since 1997, Eurobearings (EUB) has supplied tin based antifriction alloy coatings for the Power Generation market. Close collaboration with clients and constant research and development efforts over the years have led EUB to further refine its engineering and manufacturing capabilities. Today, know-how and motivation are the EUB's reliable means to provide high-quality competitive solutions. From the single bearing to the complete support.

CUSTOMER'S SATISFACTION, THE MISSION PRECEDES FUTURE, THE CHALLENGE

At EUB, research and development along with market challenges have led us to achieve excellence in bearing manufacturing technologies. Our engineering know-how, attention to customer needs, along with strong managerial and communication skills, guarantee absolute competitiveness and total satisfaction.

- > **SPECIFIC ANALYSIS**, studying the ideal solution to optimize the dynamism of the project
- > **ENGINEERING KNOW-HOW**, to lead the high quality manufacturing chain without compromises
- > **INCREASED EFFICIENCY**, by means of the specialized manufacturing technology and its lean management
- > **INCREASED RELIABILITY**, by means of the Safe Tech Coating process
- > **MODULAR CAPACITY**, extending production means while safeguarding the result
- > **REPAIR ADVANTAGE**, renewing and remodeling for best performance

EUB is the key partner for key components. Its reputation for reliable quality has made it an ideal choice in supplying complete bearing systems to the world's most powerful Hydro and Nuclear Power Plants.

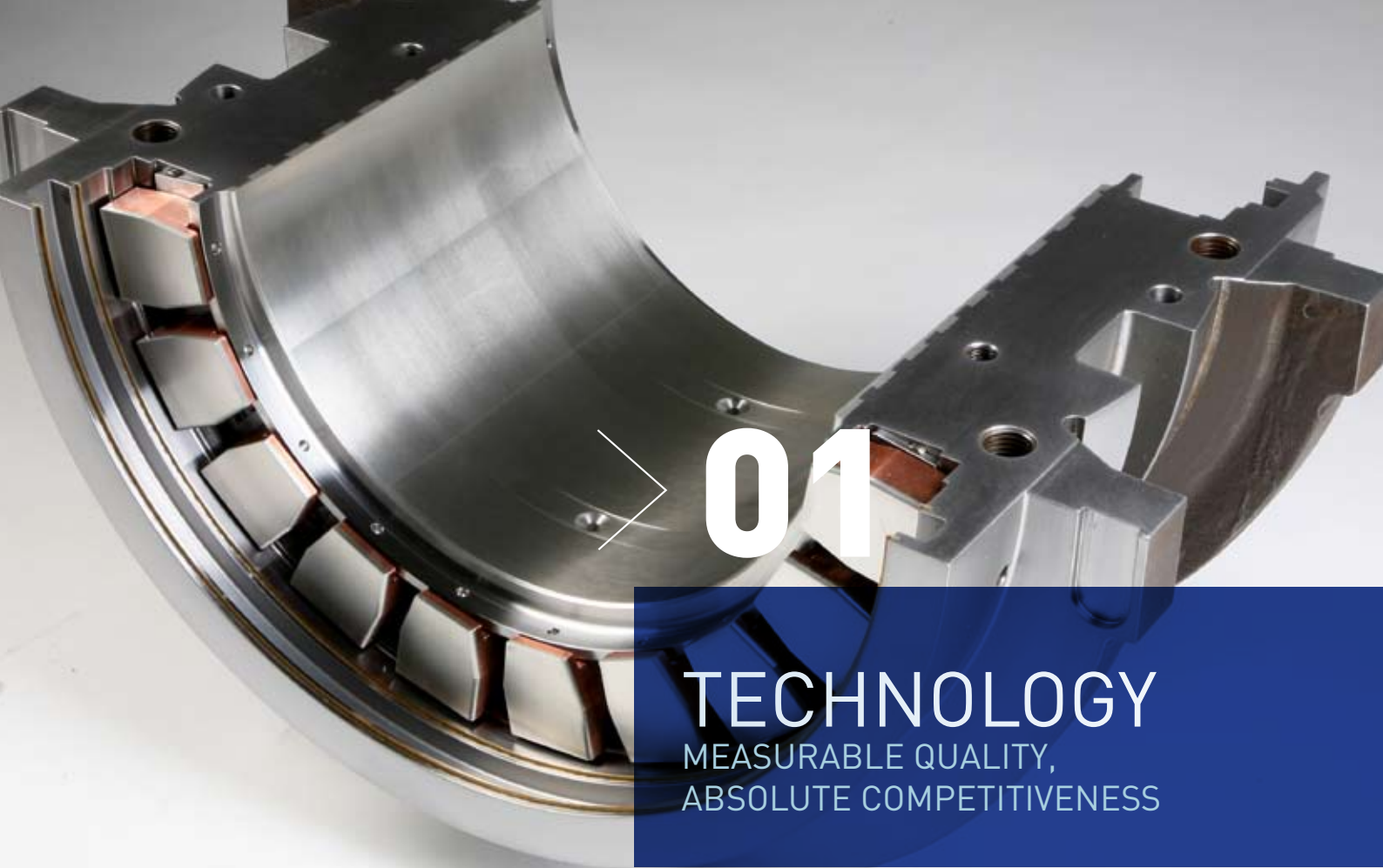

> 01

TECHNOLOGY

MEASURABLE QUALITY,
ABSOLUTE COMPETITIVENESS



EUB manufacturing provides customized production solutions on a wide range of applications:

- > BEARINGS, SEALING SYSTEMS AND COMPLETE PEDESTALS FOR **STEAM, GAS AND HYDRO TURBINES**
- > BEARINGS, SEALING SYSTEMS AND COMPLETE PEDESTALS FOR **TURBO AND HYDRO GENERATORS**
- > BEARINGS FOR **GEAR BOXES**
- > BEARINGS FOR **NAVY DIESEL ENGINES**
- > BEARINGS FOR **ROLLING MILLS**
- > BEARINGS FOR **CEMENT MILLS**

EUB flexible production can adapt to specific customer design needs on different application's fields, following any kind of specification, while applying the latest technologies in machining coating and controlling.



QUALITY ACROSS

YOUR ENERGY REVOLVES
ON OUR QUALITY



02

ENGINEERING EXPERTISE AND ACCURACY COMBINED TO GIVE THE BEST SOLUTIONS

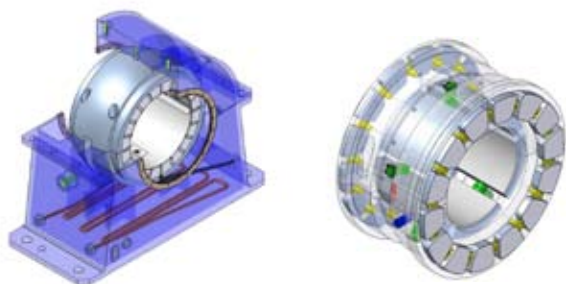

THE EUB RANGE OF STOCK PRODUCTS INCLUDE

- TILTING PAD TYPE BEARINGS
- THRUST PAD TYPE BEARINGS
- COMBINED JOURNAL AND THRUST BEARINGS
- COMPLETE HORIZONTAL BEARING PEDESTALS



At the basis of EUB engineering is a tool developed in collaboration with the Politechnical University of Milan. After years of study and running of simulations this tool accurately measures system behaviors under any working conditions. The 3D calculations and modeling are supported by a simulation test rig, designed to report back sensitive data and ensure the correct analysis of the system's criticism.

THE EUB TECHNICAL TEAM IS AVAILABLE FOR

- > ANALYSIS OF THE SYSTEM'S DYNAMICS
- > MATERIALS SUITABILITY
- > MODERNIZATION AND/OR UPGRADING OF THE SYSTEM COMPLETE DESIGN AND ITS VALIDATION
- > ISSUE OF COMPLETE TECHNICAL, USE AND QUALITY SPECIFICATION REPORT

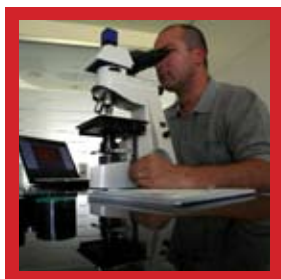

EUB is proud to base all of its activity on the constant search for total quality in each single manufacturing step. From engineering and design, to purchasing, machining and coating, the Quality Department is in charge to oversee and monitor all of the manufacturing phases.

Close inspection at each step and constant collaboration with the Production Department ensures quality in the final results, while providing data for ongoing improvements in the production processes.



03

REHABILITATION FROM REPAIR TO REVERSE ENGINEERING. OUR EXPERIENCE AT YOUR SERVICE.

Under the EUB manufacturing and design capacities a standalone Repair Division proposes its dedicated team, its fast reactions and the ability to find the proper solutions for the complete rehabilitation of bearings and associated systems.

The advantages of an independent structure, supported by the know-how and the manufacturing technologies of a leading company, ready to supply:

- > PARTIAL OR COMPLETE REHABILITATIONS
- > LOCALIZED REPAIRS
- > STANDARDIZED BRAZING/SOLDERING PROCESSES
- > SYSTEMS AND SINGLE PARTS REMODELING
- > REVERSE ENGINEERING



- > QUALIFIED OPERATORS LEVEL III AND LEVEL II FOR UT, PT, MT, VT AND RT EXAMINATIONS
- > INTERNAL LAB DEDICATED TO DESTRUCTIVE TESTS OF BOND, METALLOGRAPHIC REPLICAS AND MICROGRAPHIC EXAMINATIONS
- > METROLOGY ROOM WITH 3D MEASUREMENT/ MODELING SYSTEM

Quality Control works in cooperation with customers to guarantee the best solution, ultimately inspecting and certifying the entire supply.





Eurobearings s.r.l.
via Salvo D'Acquisto, 1
29016 Cortemaggiore (PC) IT

tel +39 0523 256111
fax +39 0523 2561224
info@eurobearings.com

www.eurobearings.com